

## ACCESORIOS PARA CABLEADO



Prensaestopa fabricada de polimeros IP66, color gris RAL 7035, para efectuar instalaciones estancas con apriete directo del cable.

**PRENSA ESTOPA DE NYLON**  
**NYLON CABLE GLANDS**



Prensaestopa fabricada de bronce IP66, para efectuar instalaciones estancas con apriete directo del cable.

**PRENSA ESTOPA DE BRONCE**  
**CABLE GLANDS**

NUMERO DE CATALOGO	MODELO	Diámetro orificio de montaje mm	Diámetros de cables		Precios
			Min mm	Max mm	
AV09P0007	PG-7	12,5	3	6	
AV09P0009	PG-9	16	5	8	
AV09P0110	PG-11	19,0	7	11	
AV09P0135	PG-13.5	20	9	13	
AV09P0160	PG-16	23,0	13	16	
AV09P0210	PG-21	29	17	20	
AV09P0290	PG-29	37,0	21	26	
AV09P0360	PG-36	48	30	34	
AV09P0420	PG-42	54,0	36	43	
AV09P0480	PG-48	60	38	50	

NUMERO DE CATALOGO	MODELO	Diámetro orificio de montaje mm	Diámetros de cables		Precios
			Min mm	Max mm	
AV08B1012	1/2"	21,0	11	14	
AV08B2014	1/4"	14	5	8	
AV08B3034	3/4"	26,5	16	19	
AV08B4038	3/8"	17	8	11	
AV08B5058	5/8"	23,0	14	17	
AV08B6100	1"	34	18	24	
AV08B7112	1-1/2"	48,0	30	38	
AV08B8114	1-1/4"	43	25	32	
AV08B9118	1-1/8"	38,0	21	27	
AV08B9200	2"	60	37	45	



Las bridas son elaboradas de nylon 6/6 color natural, autoextinguibles, con bordes laterales redondeados para facilitar la introducción en la cabeza. Rigidez dieléctrica 50.000 V/mm. Resistente al moho y a los aceites, grasas, productos derivados del petroleo, disolventes clorados, atmósferas salinas, no resistente a los fenoles.

**CINTAS AMARRACABLES COLOR NATURAL**  
**CABLE TIE IN NATURAL NYLON**



Las bridas de color negro con carga de negro humo, ademas de poseer las mismas propiedades de las de color natural, también son más resistentes a los rayos ultravioletas y a la salinidad.

**CINTAS AMARRACABLES COLOR NEGRO**  
**CABLE TIE IN BLACK NYLON**

NUMERO DE CATALOGO	MODELO	largo mm	ancho mm	Diámetro MAX.		Precios
				in	mm	
AV07L0098	5203	098	2.5			
AV07L0140	5209	140	3.6			
AV07L0160	5211	160	4.5			
AV07L0200	5215	200	4.8			
AV07L0290	5217	290	4.8			
AV07L0293	5210	290	3.6			
AV07L0360	5219	360	4.8			
AV07L0365	5227	365	7.8			
AV07L0500	5237	500	12			

NUMERO DE CATALOGO	MODELO	largo mm	ancho mm	Diámetro MAX.		Precios
				in	mm	
AV07N0098	5303	098	2.5			
AV07N0140	5309	140	3.6			
AV07N0160	5311	160	4.5			
AV07N0200	5315	200	4.8			
AV07N0290	5317	290	4.8			
AV07N0293	5210	290	3.6			
AV07N0360	5319	360	4.8			
AV07N0365	5327	365	7.8			
AV07N0500	5337	500	12			
AV07N0540	5331	540	7.8			
AV07N0750	5333	750	7.8			



Empacadura elaborada de neopreno en color negro, para colocar en la periferia interna de las tapas o puertas a objeto de garantizar el hermetismo a los distintos cerramientos. Se dispone en longitudes mínimas de un metro.

**MARQUILLAS TERMOCONTRAIBLES**  
**HEAT SHRINK**

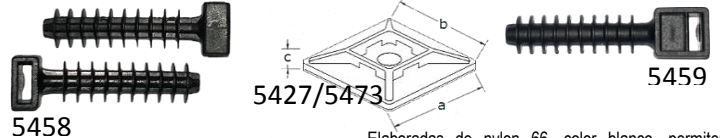

Elaboradas de nylon 66, color blanco, permiten la inserción de cintas amarra cables o tie-rop a objeto de soportar o servir de elemento de fijación a una superficie de las agrupaciones de cables

**BASE AUTOADHESIVA/RAMPLUG PARA CINTA UNIRAP**  
**SELF-ADHESIVE TIE MOUNTS**

NUMERO DE CATALOGO	MODELO	CONDUCTOR (HASTA AWG)	COLOR	Precios
MAT0012050B	12-2-9	12	BLANCO	
MAT0002050B	2-2-9	2	BLANCO	
MAT0010050B	10-2-9	10	BLANCO	
MAT0250050B	250-2-9	250	BLANCO	
MAT1000050B	1000-2-9	1000	BLANCO	

NUMERO DE CATALOGO	MODELO	a mm	b mm	c mm	Nº Vías	Precios
AV07B0001	5427	27	27	6.5	1	
AV07B0002	5473	27	27	6.5	2	
AV07B0003	5458	44	9	-	1	
AV07B0004	5459	20	10	-	1	

## ACCESORIOS PARA CABLEADO

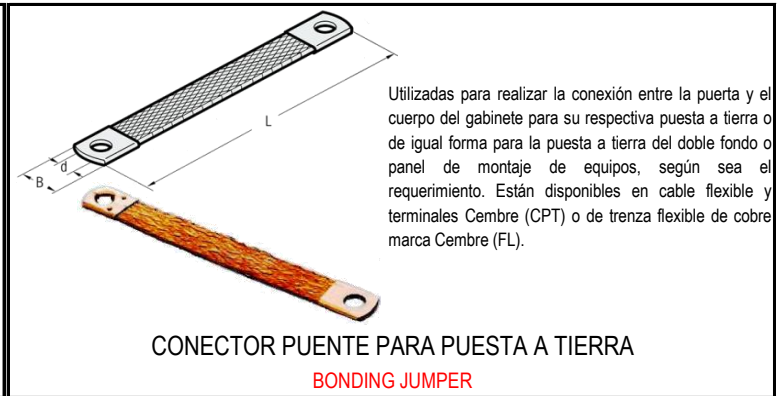

NUMERO DE CATALOGO	MODELO	ALTO mm	ANCHO mm	Sección útil mm <sup>2</sup>	Precios
CA01C2540	25X40	25	40	1000	
CA01C2560	25X60	25	60	1500	
CA01C4040	40X40	40	40	1600	
CA01C4060	40X60	40	60	2400	
CA01C4080	40X80	40	80	3200	
CA01C4100	40X100	40	100	4000	
CA01C6060	60X60	60	60	3600	
CA01C6080	60X80	60	80	4800	
CA01C6100	60X100	60	100	6000	
CA01C8060	80X60	80	60	4800	
CA01C8080	80X80	80	80	6400	
CA01C8100	80X100	80	100	8000	
CA01C9100	100X100	100	100	10000	
CA01C9120	120X60	120	60	7200	

NUMERO DE CATALOGO	MODELO	L mm	B mm	d mm	Sección mm <sup>2</sup>	Precios
TE11FL1015	FL 10-150	150	17	8,5	10	
TE11FL1020	FL 10-200	200	17	8,5	10	
TE11FL1025	FL 10-250	250	17	8,5	10	
TE11FL1615	FL 16-150	150	17	8,5	16	
TE11FL1620	FL 16-200	200	17	8,5	16	
TE11FL1625	FL 16-250	250	17	8,5	16	
TE11FL1632	FL 16-320	320	17	8,5	16	
TE11FL1635	FL 16-350	350	17	8,5	16	
TE11FL2520	FL 25-200	200	21	8,5	25	
TE11FL2525	FL 25-250	250	21	8,5	25	
TE11FL650ST	FL 16-150ST	150ST	17	8,5	16	

ST: trenza con capa de estaño

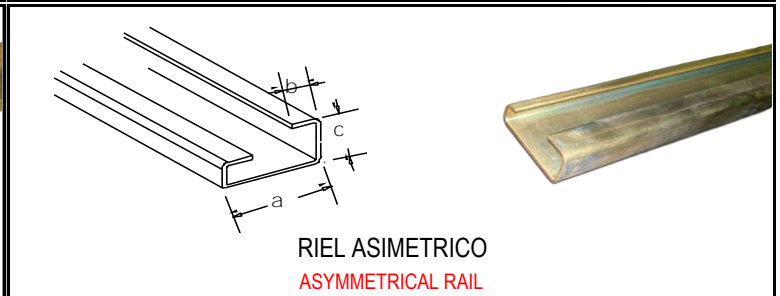
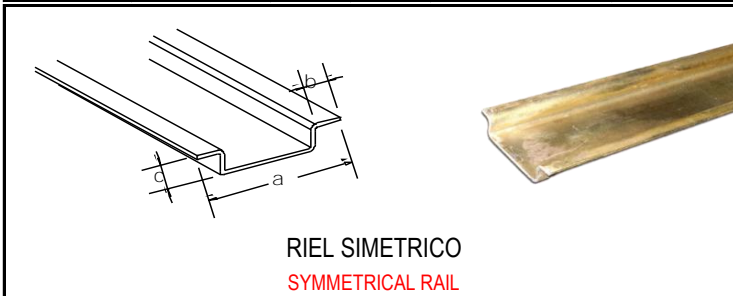

NUMERO DE CATALOGO	MODELO	a mm	b mm	c mm	e mm	Precios
B099S00P2	pregalvanizado	35	4	7.5	1.5	
B099S0002	bicromatizado	35	4	7.5	1.5	
B099S00A2	aluminio	35	4	7.5	1.6	

NUMERO DE CATALOGO	MODELO	a mm	b mm	c mm	e mm	Precios
B099S00P1	pregalvanizado	32	10.5	15	1.5	
B099S0001	bicromatizado	32	10.5	15	1.5	
B099S00A1	aluminio	32	10.5	15	1.6	

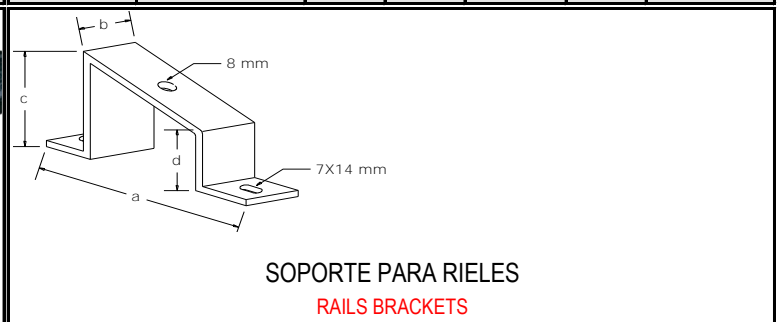
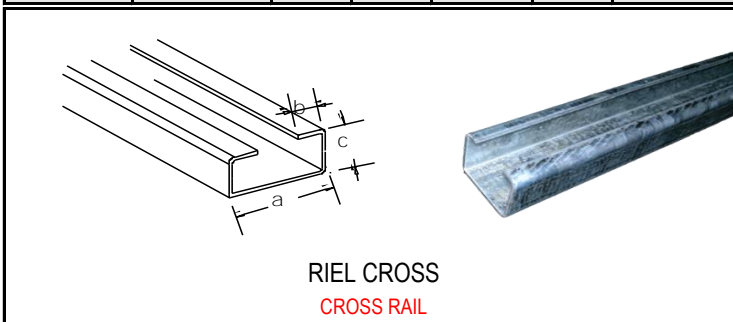

NUMERO DE CATALOGO	MODELO	a mm	b mm	c mm	e mm	Precios
AV05B00P1	pregalvanizado	25	5	15	1.2	
AV05B0005	bicromatizado	25	5	15	1.5	
AV05B00A1	aluminio	25	5	15	1.6	

NUMERO DE CATALOGO	MODELO	a mm	b mm	c mm	d mm	Precios
B099S00P5	pregalvanizado	90	25	50	25	
B099S0005	bicromatizado	90	25	50	25	
B099S00A5	aluminio	90	25	50	25	

## ACCESORIOS PARA CABLEADO



NUMERO DE CATALOGO	MODELO	CARACTERISTICAS	Precios	NUMERO DE CATALOGO	MODELO	CARACTERISTICAS	Precios
TB01L0050	TB50	TUBERIA LIQUID-TIGHT 1/2"		TB02C0038	LT-3/8"	CONECTOR RECTO L.TIGHT LT-3/8"	
TB01L0075	TB75	TUBERIA LIQUID-TIGHT 3/4"		TB02C0050	LT-1/2"	CONECTOR RECTO L.TIGHT LT-1/2"	
TB01L0100	TB100	TUBERIA LIQUID-TIGHT 1"		TB02C0075	LT-3/4"	CONECTOR RECTO L.TIGHT LT-3/4"	
TB01L0150	TB150	TUBERIA LIQUID-TIGHT 1-1/2"		TB02C0100	LT-1"	CONECTOR RECTO L.TIGHT LT-1"	
TB01L0200	TB200	TUBERIA LIQUID-TIGHT 2"		TB02C0150	LT-1-1/2"	CONECTOR RECTO L.TIGHT LT-1-1/2"	
TB01L0250	TB250	TUBERIA LIQUID-TIGHT 2-1/2"		TB02C0200	LT-2"	CONECTOR RECTO L.TIGHT LT-2"	
TB01L0300	TB300	TUBERIA LIQUID-TIGHT 3"		TB02C0250	LT-2-1/2"	CONECTOR RECTO L.TIGHT LT-2-1/2"	
TB01L0400	TB400	TUBERIA LIQUID-TIGHT 4"		TB02C0300	LT-3"	CONECTOR RECTO L.TIGHT LT-3"	
				TB02C0400	LT-4"	CONECTOR RECTO L.TIGHT LT-4"	



NUMERO DE CATALOGO	MODELO	CARACTERISTICAS	Precios	NUMERO DE CATALOGO	MODELO	a mm	b mm	d mm	Precios
TB03C0038	LT90°-3/8"	CONECTOR CURVO L.TIGHT LT90°-3/8"		AI01A0001	AISLADOR AA082-M6	25	30	6	
TB03C0050	LT90°-1/2"	CONECTOR CURVO L.TIGHT LT90°-1/2"		AI01A0002	AISLADOR 70040-M8	43	40	8	
TB03C0075	LT90°-3/4"	CONECTOR CURVO L.TIGHT LT90°-3/4"		AI01A0007	AISLADOR AA0042-M8	30	25	8	
TB03C0100	LT90°-1"	CONECTOR CURVO L.TIGHT LT90°-1"		AI01A0008	AISLADOR 71050-M8	35	32	8	
TB03C0150	LT90°-1-1/2"	CONECTOR CURVO L.TIGHT LT90°-1-1/2"		AI01A0009	AISLADOR 71080-M8	40	40	8	
TB03C0200	LT90°-2"	CONECTOR CURVO L.TIGHT LT90°-2"		AI01A0012	AISLADOR 71180-M8	51	36	8	
TB03C0250	LT90°-2-1/2"	CONECTOR CURVO L.TIGHT LT90°-2-1/2"		AI01A0016	AISLADOR 71010-M1	76	50	10	
TB03C0300	LT90°-3"	CONECTOR CURVO L.TIGHT LT90°-3"		AI01B0001	ESPARRAGO M6XL-30MM				
TB03C0400	LT90°-4"	CONECTOR CURVO L.TIGHT LT90°-4"		AI01B0002	ESPARRAGO M8XL-30MM				
				AI01B0003	ESPARRAGO M8XL-40MM				
				AI01B0004	ESPARRAGO M8XL-50MM				
				AI01B0005	ESPARRAGO M10XL-50MM				



NUMERO DE CATALOGO	MODELO	S mm	L mm	H mm	Diámetro Cable mm	Precios	NUMERO DE CATALOGO	MODELO	diámetro in mm	CARGA Lbs Kg	Precios
AV05B0002	T/1	20	18	23	10 a 25		XPN9750110	RDE 3/8	0 10	440 200	
AV05B0003	T/2	24	28	36	15 a 35		XPN9750112	RDE 1/2	1 13	1045 475	
AV05B0004	T/3	28	40	55	25 a 60						